

Position	Qty.	Description												
	1	<p data-bbox="320 338 544 365">Unilift KP 250 AV 1</p> <div data-bbox="432 409 592 752" style="text-align: center;">  </div> <p data-bbox="711 770 1193 797" style="text-align: center;">Note! Product picture may differ from actual product</p> <p data-bbox="320 801 632 862">Product No.: 012K4500 Submersible drainage pump</p> <p data-bbox="320 891 847 1008">Vertical single-stage stainless steel submersible pump with vertical discharge port and integrated submersible 1-phase canned motor in insulation class F with thermal overload protection.</p> <p data-bbox="320 1041 871 1158">The pump is fitted with suction strainer and a carrying handle and is supplied with a 5 m mains cable and vertical level switch for automatic start and stop.</p> <p data-bbox="320 1191 887 1274">The impeller is a semi-open impeller for 10 mm free passage suitable for pumping groundwater, surface water, rain water and similar liquids.</p> <p data-bbox="320 1308 884 1368">The pump has a double shaft seal consisting of two lip seals with grease in-between.</p> <p data-bbox="320 1402 887 1518">The pump has an outer casing ensuring continuous cooling of the motor by the pumped liquid. The rotor shaft operates in two maintenance-free carbon bearings cooled by the pumped liquid</p> <p data-bbox="320 1552 836 1579">The motor is filled with a non-toxic motor liquid.</p> <p data-bbox="320 1608 405 1635">Liquid:</p> <table data-bbox="320 1637 916 1727"> <tr> <td>Pumped liquid:</td> <td>Any Newtonian liquid</td> </tr> <tr> <td>Liquid temperature range:</td> <td>0 .. 50 °C</td> </tr> <tr> <td>Density:</td> <td>998.2 kg/m³</td> </tr> </table> <p data-bbox="320 1756 443 1783">Technical:</p> <table data-bbox="320 1785 759 1816"> <tr> <td>Maximum particle size:</td> <td>10 mm</td> </tr> </table> <p data-bbox="320 1845 437 1872">Materials:</p> <table data-bbox="320 1874 887 2051"> <tr> <td>Pump housing:</td> <td>Stainless steel DIN W.-Nr. 1.4301 AISI 304</td> </tr> <tr> <td>Impeller:</td> <td>Stainless steel DIN W.-Nr. 1.4031 AISI 304</td> </tr> </table> <p data-bbox="320 2080 459 2107">Installation:</p>	Pumped liquid:	Any Newtonian liquid	Liquid temperature range:	0 .. 50 °C	Density:	998.2 kg/m ³	Maximum particle size:	10 mm	Pump housing:	Stainless steel DIN W.-Nr. 1.4301 AISI 304	Impeller:	Stainless steel DIN W.-Nr. 1.4031 AISI 304
Pumped liquid:	Any Newtonian liquid													
Liquid temperature range:	0 .. 50 °C													
Density:	998.2 kg/m ³													
Maximum particle size:	10 mm													
Pump housing:	Stainless steel DIN W.-Nr. 1.4301 AISI 304													
Impeller:	Stainless steel DIN W.-Nr. 1.4031 AISI 304													

Position	Qty.	Description
		Pump outlet: Rp 1 1/4 Maximum installation depth: 2 m Electrical data: Power input - P1: 480 W C run: 8 µF Mains frequency: 50 Hz Rated voltage: 1 x 230-240 V Rated current: 2.2 A Capacitor size - run: 8 µF/400 V Enclosure class (IEC 34-5): IP68 Insulation class (IEC 85): F Length of cable: 5 m Type of cable plug: AU Others: Net weight: 7 kg Gross weight: 7.3 kg Shipping volume: 0.013 m ³

012K4500 Unilift KP 250 AV 1 50 Hz

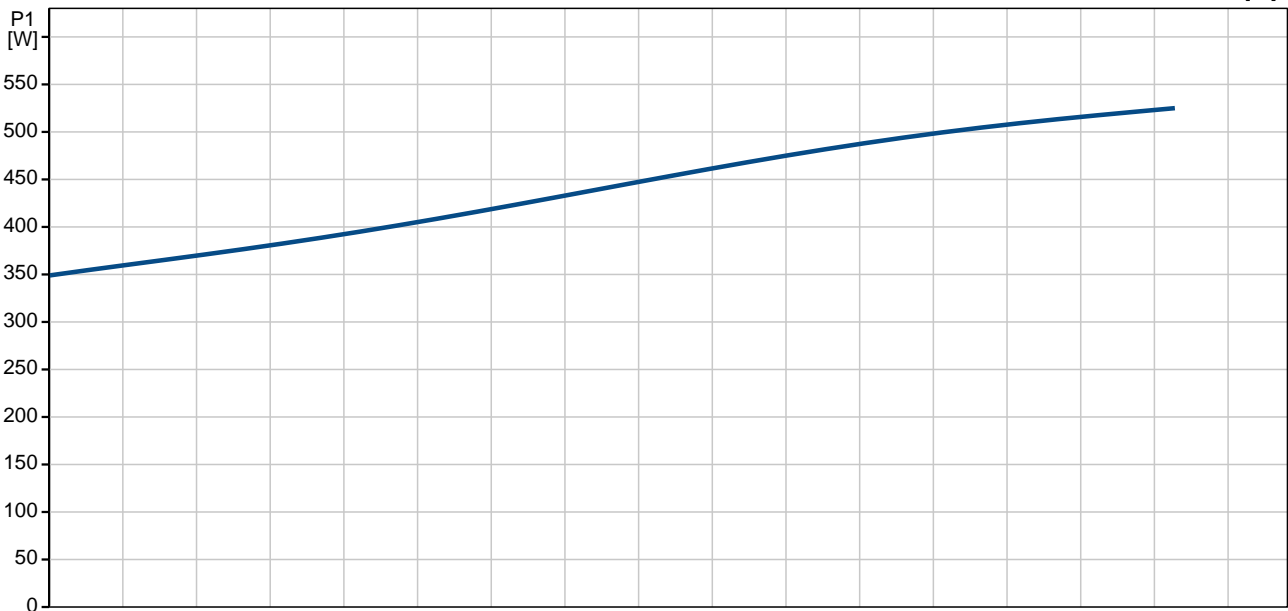
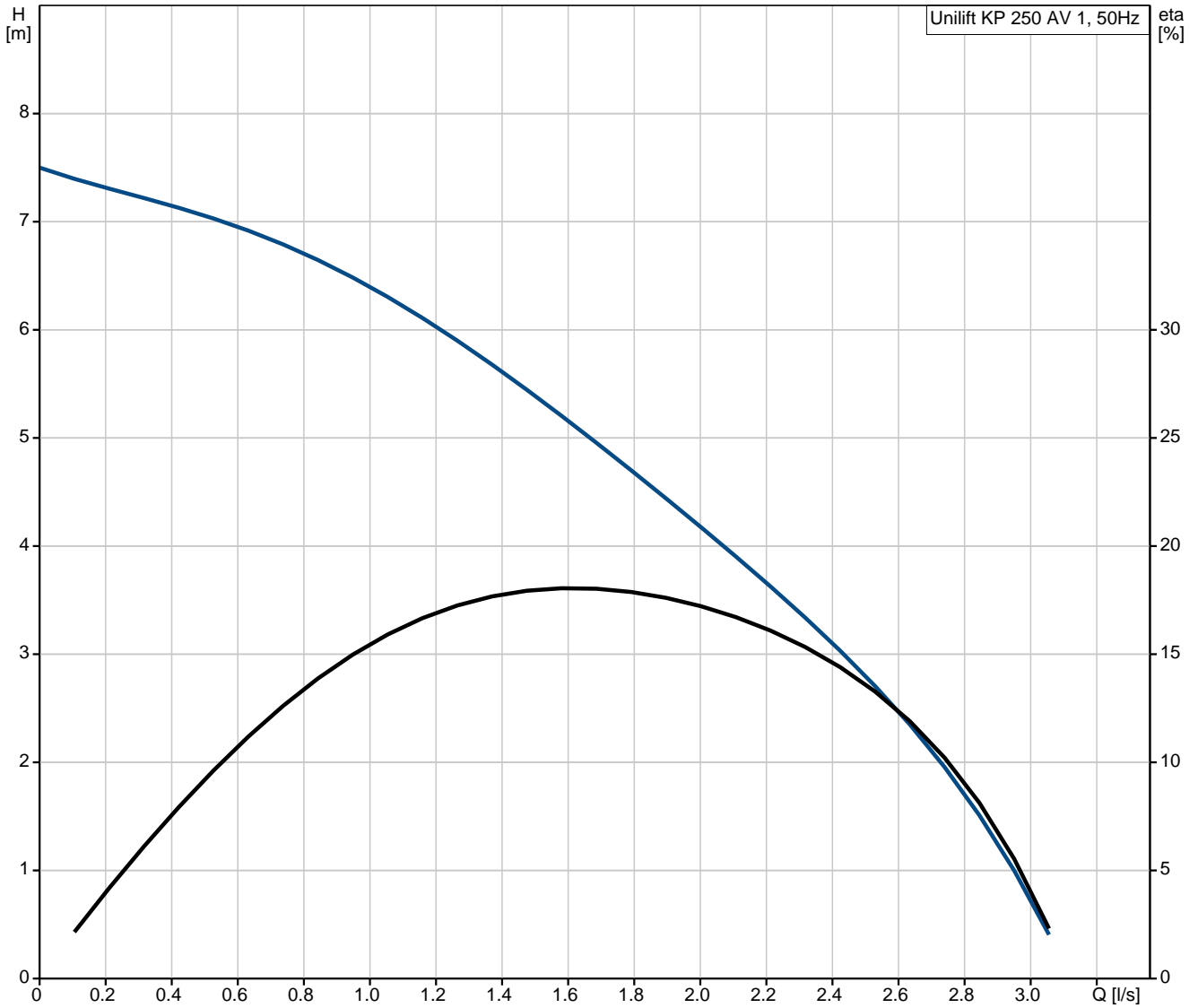

Description	Value
-------------	-------

General information:

Product name:	Unilift KP 250 AV 1
Product No:	012K4500
EAN number:	5700391248757
Price:	On request

Technical:

Max flow:	3.11 l/s
Head max:	7.5 m
Maximum particle size:	10 mm
Model:	A

Materials:

Pump housing:	Stainless steel DIN W.-Nr. 1.4301 AISI 304
Impeller:	Stainless steel DIN W.-Nr. 1.4031 AISI 304

Installation:

Pump outlet:	Rp 1 1/4
Maximum installation depth:	2 m

Liquid:

Pumped liquid:	Any Newtonian liquid
Liquid temperature range:	0 .. 50 °C
Density:	998.2 kg/m ³

Electrical data:

Power input - P1:	480 W
C run:	8 µF
Mains frequency:	50 Hz
Rated voltage:	1 x 230-240 V
Rated current:	2.2 A
Capacitor size - run:	8 µF/400 V
Enclosure class (IEC 34-5):	IP68
Insulation class (IEC 85):	F
Motor protec:	CONTACT
Thermal protec:	internal
Length of cable:	5 m
Type of cable plug:	AU

Controls:

Level switch:	vertical level switch
---------------	-----------------------

Others:

Net weight:	7 kg
Gross weight:	7.3 kg
Shipping volume:	0.013 m ³

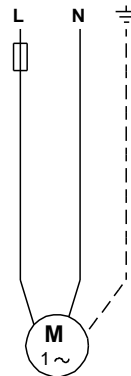
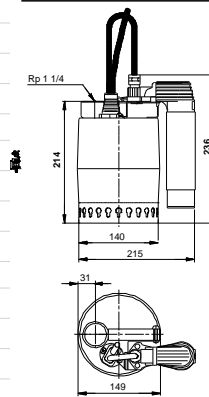
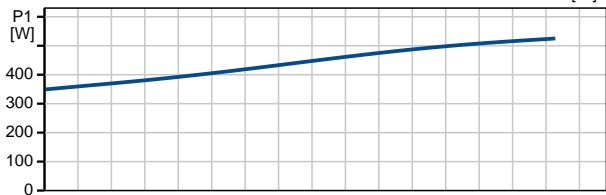
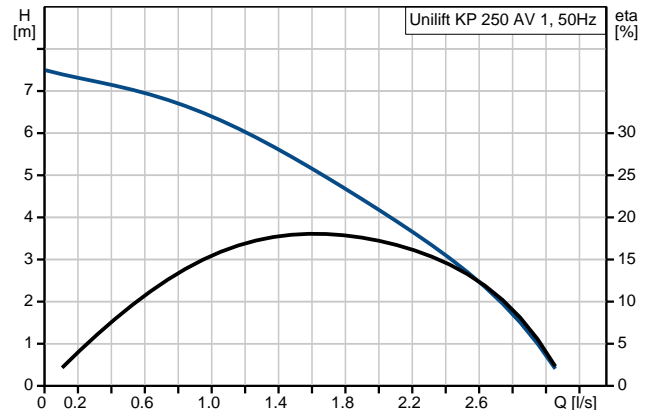

012K4500 Unilift KP 250 AV 1 50 Hz

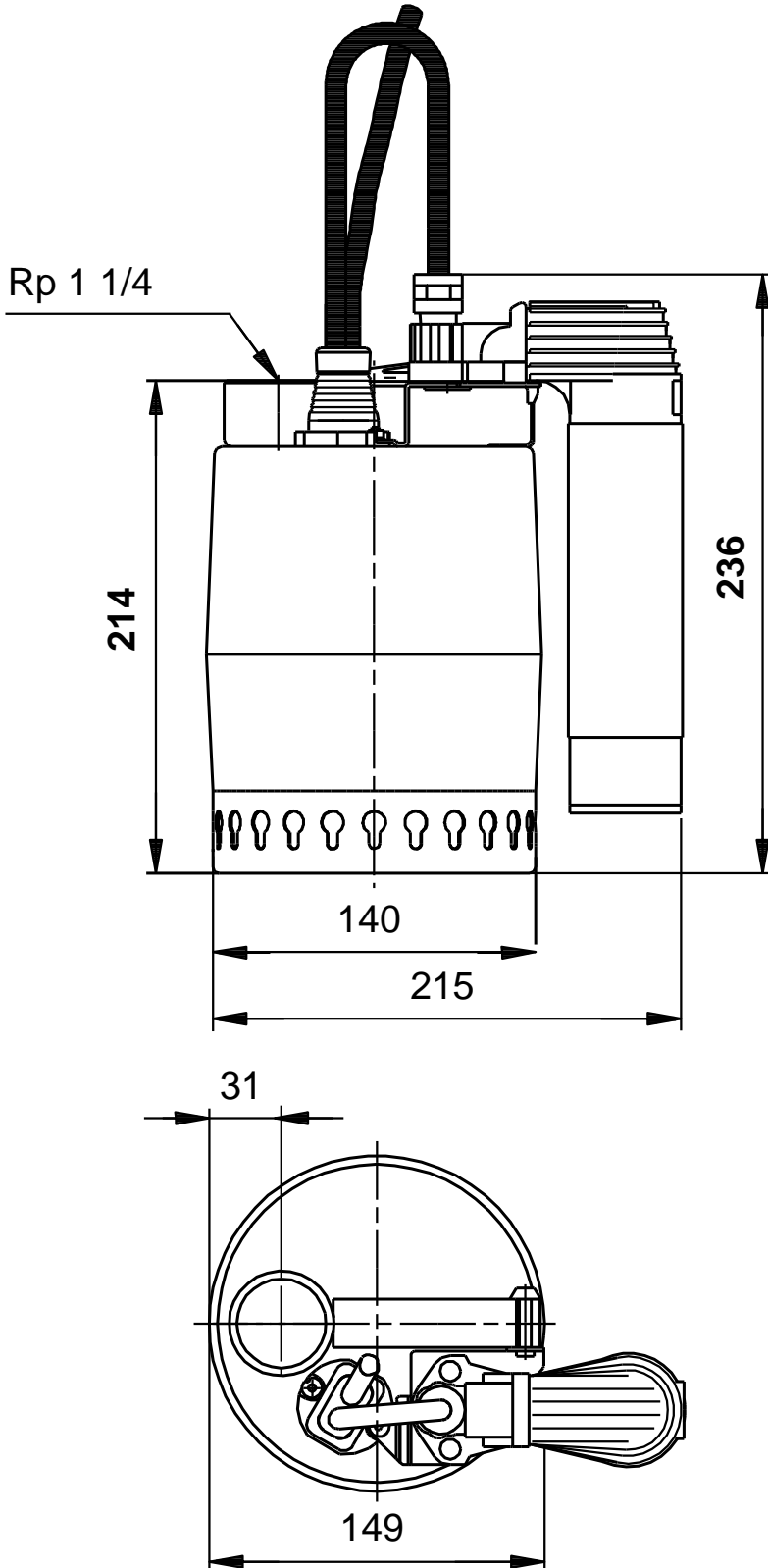

Note! All units are in [mm] unless others are stated.
Disclaimer: This simplified dimensional drawing does not show all details.

012K4500 Unilift KP 250 AV 1 50 Hz



Note! All units are in [mm] unless others are stated.