

Position	Qty.	Description
	1	<p>Unilift KP 250 M 1</p>  <p style="text-align: center;">Note! Product picture may differ from actual product</p> <p>Product No.: 012K4100 Submersible drainage pump</p> <p>Vertical single-stage stainless steel submersible pump with vertical discharge port and integrated submersible 1-phase canned motor in insulation class F with thermal overload protection.</p> <p>The pump is fitted with a suction strainer, a carrying handle and is supplied with a 5 m mains cable.</p> <p>The impeller is a semi-open impeller for 10 mm free passage suitable for pumping groundwater, surface water, rain water and similar liquids.</p> <p>The pump has a double shaft seal consisting of two lip seals with grease in-between.</p> <p>The pump has an outer casing ensuring continuous cooling of the motor by the pumped liquid. The rotor shaft operates in two maintenance-free carbon bearings cooled by the pumped liquid</p> <p>The motor is filled with a non-toxic motor liquid.</p> <p>Liquid: Pumped liquid: Any Newtonian liquid Liquid temperature range: 0 .. 50 °C Density: 998.2 kg/m³</p> <p>Technical: Maximum particle size: 10 mm</p> <p>Materials: Pump housing: Stainless steel DIN W.-Nr. 1.4301 AISI 304 Impeller: Stainless steel DIN W.-Nr. 1.4031 AISI 304</p> <p>Installation:</p>

Position	Qty.	Description
		Pump outlet: Rp 1 1/4 Maximum installation depth: 2 m Electrical data: Power input - P1: 480 W C run: 8 µF Mains frequency: 50 Hz Rated voltage: 1 x 230-240 V Rated current: 2.2 A Capacitor size - run: 8 µF/400 V Enclosure class (IEC 34-5): IP68 Insulation class (IEC 85): F Length of cable: 5 m Type of cable plug: AU Others: Net weight: 6.5 kg Gross weight: 7 kg Shipping volume: 0.013 m ³

012K4100 Unilift KP 250 M 1 50 Hz

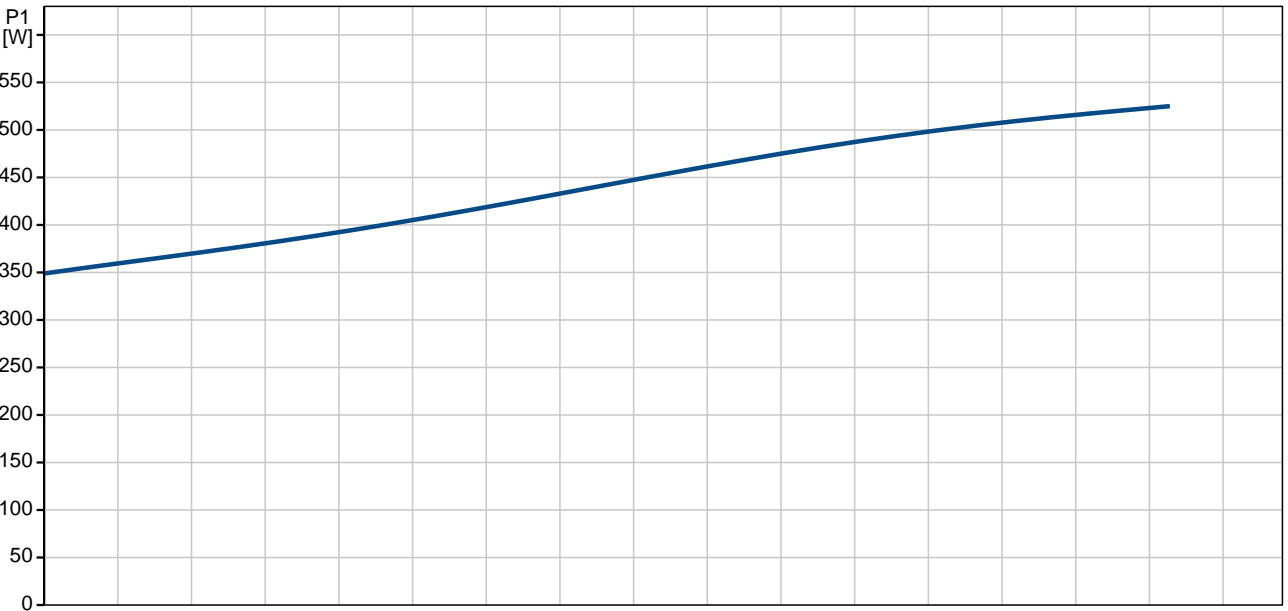
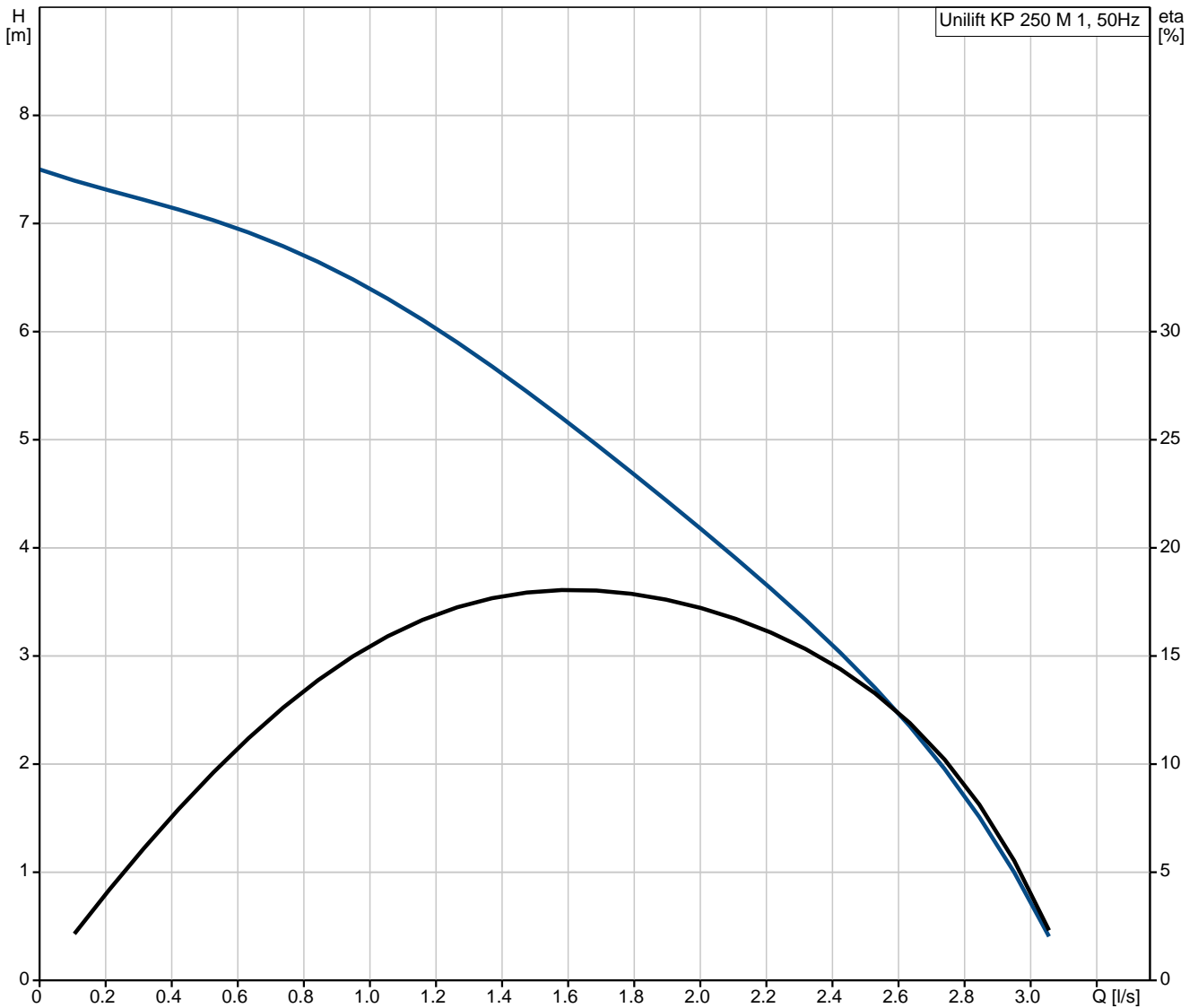

Description	Value
-------------	-------

General information:

Product name:	Unilift KP 250 M 1
Product No:	012K4100
EAN number:	5700391248726
Price:	On request

Technical:

Max flow:	3.11 l/s
Head max:	7.5 m
Maximum particle size:	10 mm
Model:	A

Materials:

Pump housing:	Stainless steel DIN W.-Nr. 1.4301 AISI 304
Impeller:	Stainless steel DIN W.-Nr. 1.4031 AISI 304

Installation:

Pump outlet:	Rp 1 1/4
Maximum installation depth:	2 m

Liquid:

Pumped liquid:	Any Newtonian liquid
Liquid temperature range:	0 .. 50 °C
Density:	998.2 kg/m ³

Electrical data:

Power input - P1:	480 W
C run:	8 µF
Mains frequency:	50 Hz
Rated voltage:	1 x 230-240 V
Rated current:	2.2 A
Capacitor size - run:	8 µF/400 V
Enclosure class (IEC 34-5):	IP68
Insulation class (IEC 85):	F
Motor protec:	CONTACT
Thermal protec:	internal
Length of cable:	5 m
Type of cable plug:	AU

Others:

Net weight:	6.5 kg
Gross weight:	7 kg
Shipping volume:	0.013 m ³

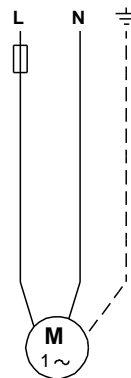
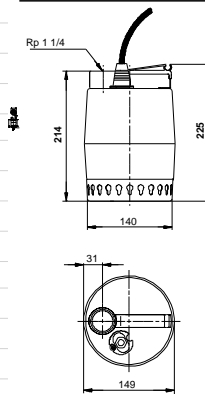
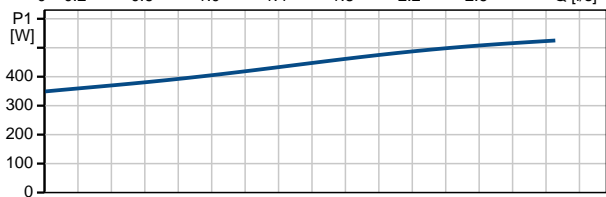
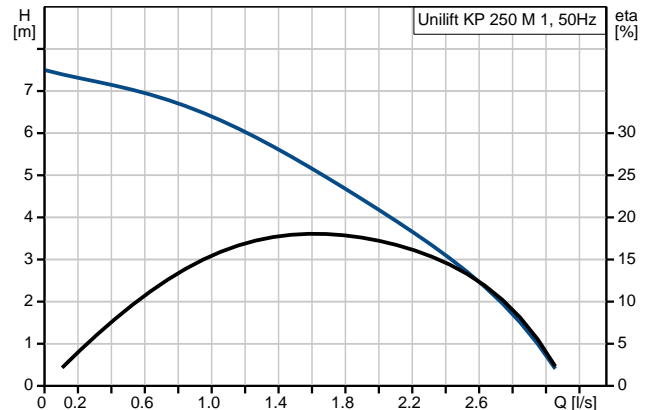

012K4100 Unilift KP 250 M 1 50 Hz

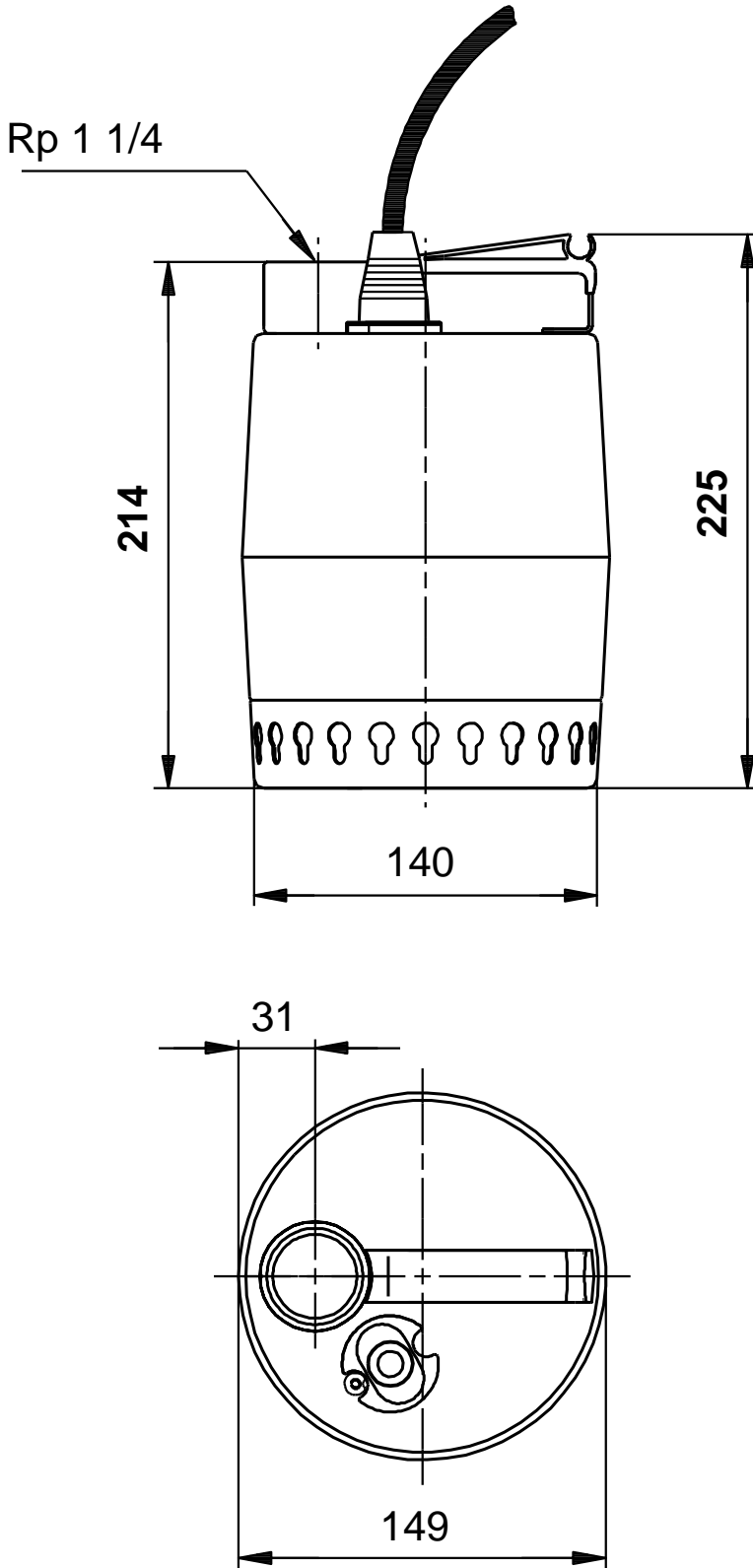

Note! All units are in [mm] unless others are stated.
Disclaimer: This simplified dimensional drawing does not show all details.

012K4100 Unilift KP 250 M 1 50 Hz

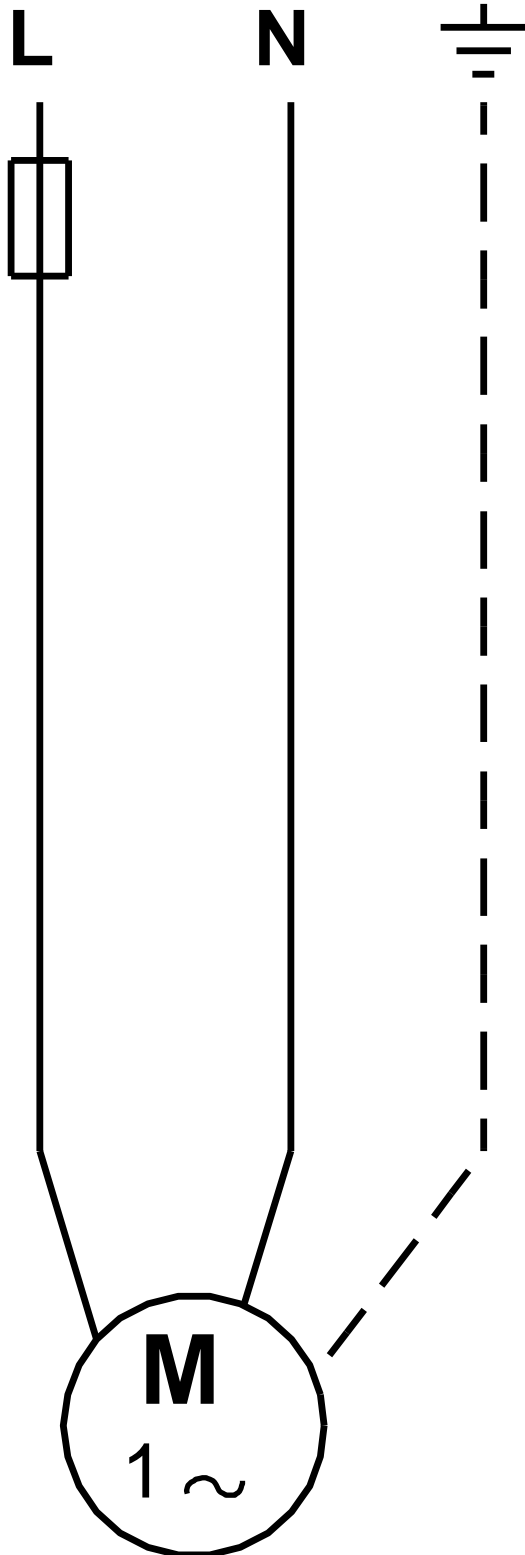

Note! All units are in [mm] unless others are stated.